

## Outdoor Enclosure with 5GHz 17dBi Panel Antenna



**Model: MJE-5N17**

### KEY FEATURES

- Weatherproof IP53 Enclosure
- 17dBi Long Distance Antenna

### APPLICATIONS

- Outdoor Long Distance Point-to-Point (PtP) AP
- Point-to-MultiPoint (PtMP) AP
- Outdoor Mesh AP

## Enclosure Specifications

Material	ABS/PC, Flame Retardant, UV resistant
Color	White
Weight	0.5kg
Integrated Antenna	5GHz 17dBi panel antenna
Ethernet Interface	RJ45
Casing	Weatherproof Structure
Rating of Enclosure	IP53
Mounting	Pole Mount or Wall Mount
Dimensions (H x W x D)	278.5mm x 122.2mm x 94.5mm

## Dimensional Drawing

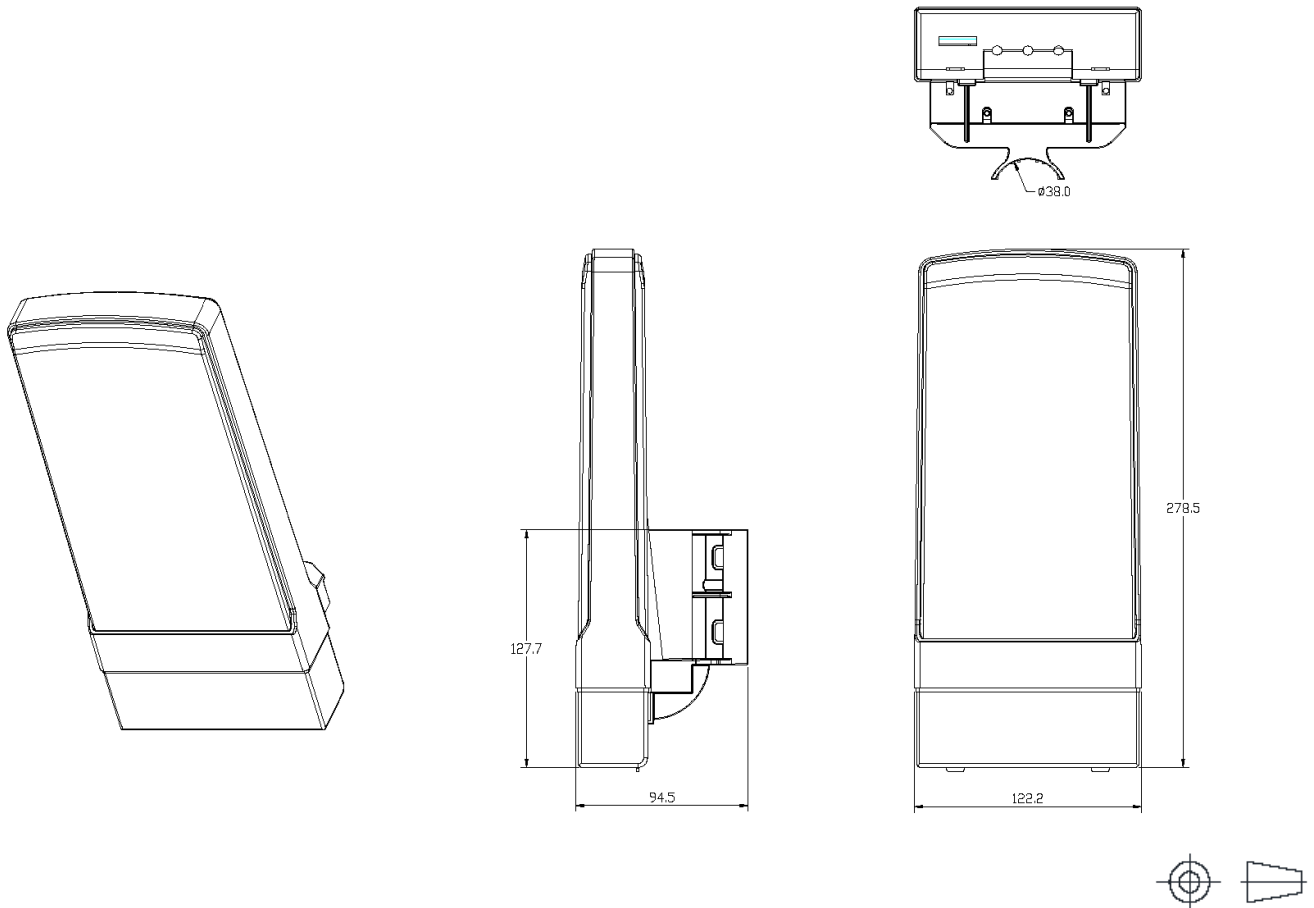

## Features and Illustrations

Features	Illustrations
<p>Antenna Port Orientation</p>	
<p>Mounting</p>	

## Antenna Element Specifications

Gain	17dBi
Radiation	Directional
Connectors	2x U.FL or MMCX Antenna Connectors
Frequency Range	5.1 ~ 5.9 GHz
Polarization	Dual Polarization
Azimuth -3dB Beamwidth	Horizontal (Port 1) : 30 degrees Vertical (Port 2) : 33 degrees
Elevation -3dB Beamwidth	Horizontal (Port 1) : 17 degrees Vertical (Port 2) : 17 degrees
Dimensions of antenna PCB (H x W x D)	160mm x 80mm x 1mm
Dimensions of metal ground plane reflector (H x W x D)	210mm x 105mm x 4.5mm

## Antenna Element Specifications

Isolation	40dB (Min)
Front-to-Back Ratio	30dB (Min)
VSWR	Horizontal (Port 1) : < 1.87:1 Vertical (Port 2) : < 1.55:1
Cross Polarization Isolation	28dB (Min)
SideLobe	< -12dB

Gain Plot

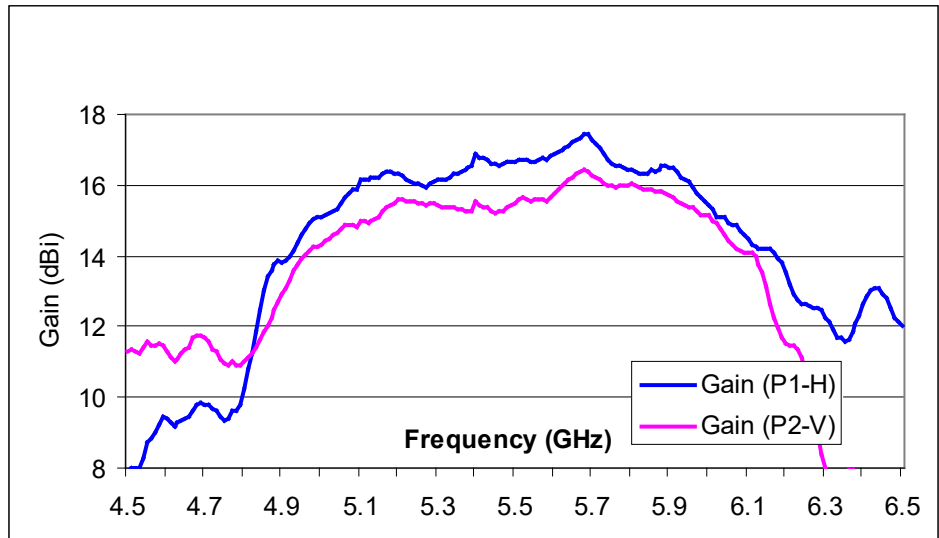

S-Parameters Graph:  
Return Loss  
and Isolation

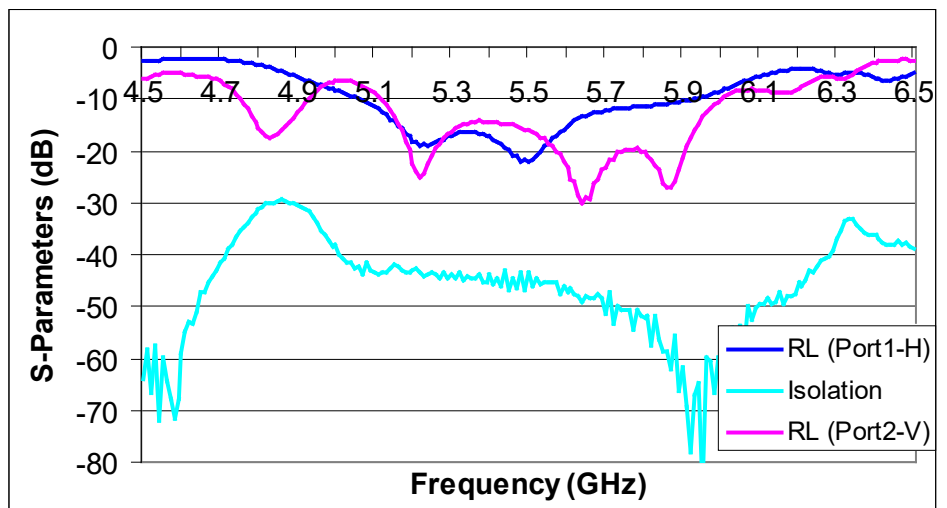

## Antenna Element Specifications

Polar Plots (At 5.6 GHz)

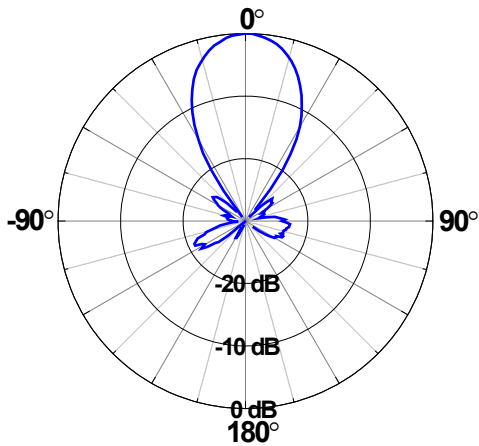

H-Pol Azimuth (Port 1 - H)

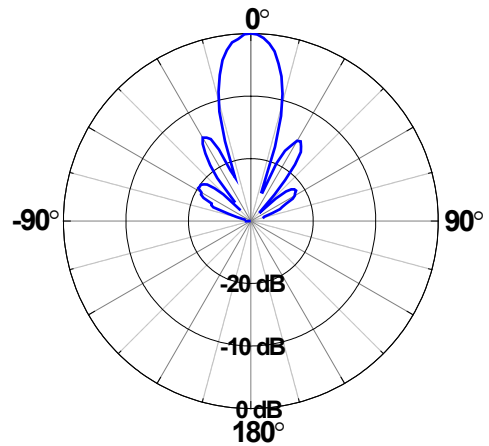

H-Pol Elevation (Port 1 - H)

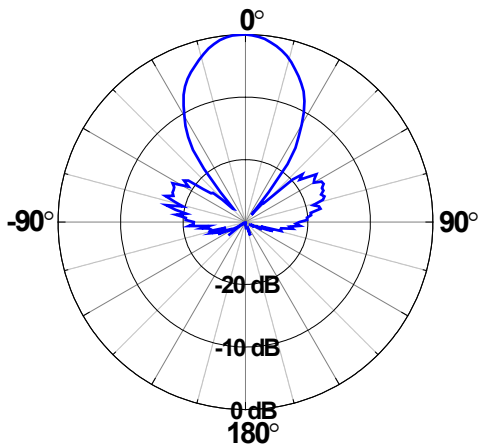

V-Pol Azimuth (Port 2 - V)

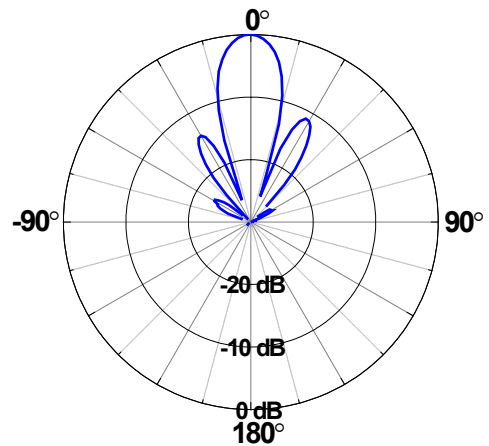

V-Pol Elevation (Port 2 - V)